

MS1 series servo motors

Highly dynamic motors with a wide range of brake options and motor cables



- Rated power: 50 W – 7.5 kW
- Rated torque: 0.16 - 48 N·m
- Base speed: 3,000 and 1,500 rpm (to 6,000 rpm max.)
- Low and medium inertia types
- Frame sizes (mm) 40, 60, 80, 100, 130 and 180



MS1 series – features & functions

Common family features:

- IP67 rating
- Complies with CE and UL
- Inovance serial encoder options:
 - Standard - 23 bit: ± 15 arcseconds
 - Option - 26 bit: ± 2 arcseconds
 - Single or multi-turn* absolute operation
- Applicable drives: IS810, SV660, SV670, SV680



*Battery supported

MS1H1/H4 series:

- From 0.16 to 3.2 N·m
- Easy-to-use connectors
- Max. peak torque: 350%
- Torque ripple <0.5%

MS1H2/H3 series:

- From 3.2 to 48 N·m
- Military spec. connectors
- Max. peak torque: 300%
- Torque ripple <1%









Voltage		
Frame	40 x 40	60 x 60
Appearance		
Type Codes	MS1H1-05B30CB-A3XXZ MS1H1-10B30CB-A3XXZ	MS1H1-20B30CB-A3XXZ MS1H1-40B30CB-A3XXZ MS1H1-60B30CB-A3XXZ
Rated Speed (rpm)	3000	3000
Rated Power (W)	50 - 100	200 - 400
Rated Torque (N-m)	0.16 - 0.32	0.64 - 1.28
Applicable Drives		



IS810

MS1 motors selection chart



220V				400V			
60	80 x 80	100 x 100	130 x 130	100 x 100	130 x 130	130 x 130	180 x 180
							
MS1H1- 3-A3XXZ	MS1H1- 55B30CB-A3XXZ MS1H1- 75B30CB-A3XXZ MS1H4- 75B30CB-A3XXZ MS1H1- 10C30CB-A3XXZ	MS1H2- 10C30CB-A3XXZ MS1H2- 15C30CB-A3XXZ	MS1H3- 85B15CB-A3XXZ MS1H3- 13C15CB-A3XXZ	MS1H2- 10C30CD-A3XXZ MS1H2- 15C30CD-A3XXZ MS1H2- 20C30CD-A3XXZ MS1H2- 25C30CD-A3XXZ	MS1H2- 30C30CD-A3XXZ MS1H2- 40C30CD-A3XXZ MS1H2- 50C30CD-A3XXZ	MS1H3- 85B15CD-A3XXZ MS1H3- 13C15CD-A3XXZ MS1H3- 18C15CD-A3XXZ	MS1H3- 29C15CD-A3XXZ MS1H3- 44C15CD-A3XXZ MS1H3- 55C15CD-A3XXZ MS1H3- 75C15CD-A3XXZ
00	3000	3000	1500	3000	3000	1500	1500
400	550 - 1000	1000 - 1500	850 - 1300	1000 - 2500	3000 - 5000	850 - 1800	2900 - 7500
1.27	1.75 - 3.18	3.18 - 4.90	5.39 - 8.34	3.18 - 7.96	9.8 - 15.8	5.39 - 11.5	18.6 - 48.0
IS810, SV660, SV670, SV680							

Applicable drives: IS810, SV660, SV670, SV680



SV660



SV670



SV680

MS1 servo motor technical data

Product ordering code

MS1 H1 - 75B 30C B - A3 3 1 Z - INT

① ② ③ ④ ⑤ ⑥ ⑦ ⑧ ⑨ ⑩

① **Series: MS1 series servo motor**

② **Inertia**

H1: low inertia, 40/60/80 mm flange, 3,000 RPM
 H2: low inertia, 100/130 mm flange, 3,000 RPM
 H3: medium inertia 130/180 mm flange, 1,500 RPM
 H4: medium inertia 60/80 mm flange, 3,000 RPM

③ **Rated power**

A: x 1
 B: x 10
 C: x 100
 D: x 1,000
 E: x 10,000
 E.g. 75B: 750 W: 15C: 1,500 W

④ **Rated speed**

A: x 1
 B: x 10
 C: x 100
 D: x 1,000
 E: x 10,000
 E.g. 30C : 3,000 RPM

⑤ **Voltage class**

B: 220 V
 D: 400 V

⑥ **Encoder type**

A3: 23-bit single & multi-turn absolute
 A6: 26-bit

⑦ **Motor shaft**

1: plain
 2: keyed
 3: keyed + tapped hole
 5: tapped hole

⑧ **Brake and oil seal options**

0: no brake, no oil seal
 1: oil seal
 2: brake
 4: brake + oil seal

⑨ **Stator pole:**

Y: 8 pole
 Z: 10 pole

⑩ **INT: international version**

Servo motor model	Rated output [kW]	Rated torque [Nm]	Peak torque [Nm]	Rated current [Arms]	Peak current [Arms]	Rated speed [RPM]	Max speed [RPM]	Torque constant [Nm/Arms]	Rotor inertia [10 ⁻⁴ x kg·m ²]		Voltage [V]
									Without brake	With brake	
MS1H1 (Nrated = 3,000 RPM, Nmax = 6,000 RPM)											
MS1H1-05B30CB-XXXXZ-INT	0.05	0.16	0.56	1.3	4.7	3,000	6,000	0.15	0.026	0.028	220
MS1H1-10B30CB-XXXXZ-INT	0.1	0.32	1.12	1.3	4.7			0.26	0.041	0.043	
MS1H1-20B30CB-XXXXZ-INT	0.2	0.64	2.24	1.5	5.8			0.46	0.207	0.220	
MS1H1-40B30CB-XXXXZ-INT	0.4	1.27	4.46	2.8	10.1			0.53	0.376	0.390	
MS1H1-55B30CB-XXXXZ-INT	0.55	1.75	6.13	3.8	15.0			0.49	1.06	1.06	
MS1H1-75B30CB-XXXXZ-INT	0.75	2.39	8.36	4.8	16.9			0.58	1.38	1.43	
MS1H1-10C30CB-XXXXZ-INT	1.0	3.18	11.1	7.6	28			0.46	1.75	1.75	
MS1H2 (Nrated = 3,000 RPM, Nmax = 5,000/6,000 RPM)											
MS1H2-10C30CB-XXXXZ-INT	1.0	3.18	9.54	7.5	23	3,000	6,000	0.43	1.87	3.12	220
MS1H2-15C30CB-XXXXZ-INT	1.5	4.9	14.7	10.8	32		5,000	0.45	2.46	3.71	
MS1H2-10C30CD-XXXXZ-INT	1.0	3.18	9.54	3.65	11		6,000	0.87	1.87	3.12	
MS1H2-15C30CD-XXXXZ-INT	1.5	4.9	14.7	4.5	14		5,000	1.09	2.46	3.71	400
MS1H2-20C30CD-XXXXZ(-S4)-INT	2.0	6.36	19.1	5.89	20			1.08	3.06	4.31	
MS1H2-25C30CD-XXXXZ(-S4)-INT	2.5	7.96	23.9	7.56	25			1.05	3.65	4.9	
MS1H2-30C30CD-XXXXZ(-S4)-INT	3.0	9.8	29.4	10	30			0.98	7.72	7.72	
MS1H2-40C30CD-XXXXZ(-S4)-INT	4.0	12.6	37.8	13.6	40.8			0.93	12.1	14.6	
MS1H2-50C30CD-XXXXZ(-S4)-INT	5.0	15.8	47.6	16	48			1.07	15.4	17.9	
MS1H3 (Nrated = 1,500 RPM, Nmax = 3,000 RPM)											
MS1H3-85B15CB-XXXXZ-INT	0.85	5.39	13.5	6.6	16.5	1,500	3,000	0.9	13.3	14	220
MS1H3-13C15CB-XXXXZ-INT	1.3	8.34	20.85	10	25			0.9	17.8	18.5	
MS1H3-85B15CD-XXXXZ-INT	0.85	5.39	13.5	3.3	8.25			1.75	13.3	14	
MS1H3-13C15CD-XXXXZ-INT	1.3	8.34	20.85	5	12.5			1.78	17.8	18.5	400
MS1H3-18C15CD-XXXXZ-INT	1.8	11.5	28.75	6.6	16.5			1.8	25	25.7	
MS1H3-29C15CD-XXXXZ-INT	2.9	18.6	37.2	11.9	28			1.7	55	57.2	
MS1H3-44C15CD-XXXXZ-INT	4.4	28.4	71.1	16.5	40.5			1.93	88.9	90.8	
MS1H3-55C15CD-XXXXZ-INT	5.5	35	87.6	20.85	52			1.8	107	109.5	
MS1H3-75C15CD-XXXXZ-INT	7.5	48	119	25.7	65			1.92	141	143.1	
MS1H4 (Nrated = 3,000 RPM, Nmax = 6,000 RPM)											
MS1H4-40B30CB-XXXXZ-INT	0.4	1.27	4.46	2.8	10.1	3,000	6,000	0.53	0.657	0.667	220
MS1H4-75B30CB-XXXXZ-INT	0.75	2.39	8.36	4.8	16.9			0.58	2	2.012	

Notes: Type codes with S4 indicate motors with brakes that can be applied on a discontinuous cycle or an RMS load with 70% of the rated torque

Servo motor dimensions

MS1H1/MS1H4 mounting dimensions ($N_{\text{rated}} = 3,000 \text{ RPM}$, $N_{\text{max}} = 6,000 \text{ RPM}$)

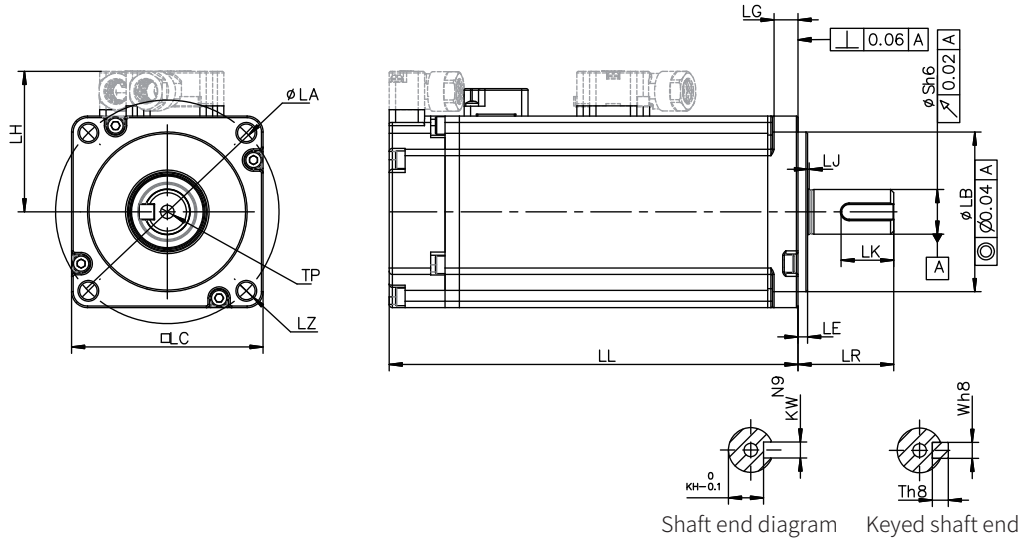

Model	LC (mm)	LL (mm)	LR (mm)	LA (mm)	LZ (mm)	LH (mm)	LG (mm)	LE (mm)	LJ (mm)
MS1H1-05B30CB-XXXXZ-INT	40	65 (96)*	25±0.5	46	2-Φ4.5	34	5	2.5±0.5	0.5±0.35
MS1H1-10B30CB-XXXXZ-INT	40	77.5 (109)*	25±0.5	46	2-Φ4.5	34	5	2.5±0.5	0.5±0.35
MS1H1-20B30CB-XXXXZ-INT	60	72.5 (100)*	30±0.5	70	4-Φ5.5	44	7.5	3±0.5	0.5±0.35
MS1H1-40B30CB-XXXXZ-INT	60	91 (119)*	30±0.5	70	4-Φ5.5	44	7.5	3±0.5	0.5±0.35
MS1H1-55B30CB-XX31Z-INT	80	96.2	35±0.5	90	4-Φ7	54	7.7	3±0.5	0.5±0.35
MS1H1-75B30CB-XXXXZ-INT	80	107 (140)*	35±0.5	90	4-Φ7	54	7.7	3±0.5	0.5±0.35
MS1H1-10C30CB-XX31Z-INT	80	118.2	35±0.5	90	4-Φ7	54	7.7	3±0.5	0.5±0.35
MS1H4-40B30CB-XXXXZ-INT	60	105 (128)*	30±0.5	70	4-Φ5.5	44	7.5	3±0.3	0.5±0.35
MS1H4-75B30CB-XXXXZ-INT	80	117.5 (147.5)*	35±0.5	90	4-Φ7	54	7.7	3±0.3	0.5±0.35

Model	LB (mm)	S (mm)	TP (mm)	LK (mm)	KH (mm)	KW (mm)	W (mm)	T (mm)	Weight (kg)
MS1H1-05B30CB-XXXXZ-INT	30	8	M3×6	15.5	6.2	3	3	3	0.39 (0.50)*
MS1H1-10B30CB-XXXXZ-INT	30	8	M3×6	15.5	6.2	3	3	3	0.45 (0.64)*
MS1H1-20B30CB-XXXXZ-INT	50	14	M5×8	16.5	11	5	5	5	0.78 (1.16)*
MS1H1-40B30CB-XXXXZ-INT	50	14	M5×8	16.5	11	5	5	5	1.11 (1.48)*
MS1H1-55B30CB-XX31Z-INT	70	19	M6×20	25	15.5	6	6	6	1.85
MS1H1-75B30CB-XXXXZ-INT	70	19	M6×20	25	15.5	6	6	6	2.18 (2.82)*
MS1H1-10C30CB-XX31Z-INT	70	19	M6×20	25	15.5	6	6	6	2.55
MS1H4-40B30CB-XXXXZ-INT	50	14	M5×8	16.5	11.0	5	5	5	1.27 (1.62)*
MS1H4-75B30CB-XXXXZ-INT	70	19	M6×20	25	15.5	6	6	6	2.40 (3.04)*

*Refers to braked version of the motor

Servo motor dimensions

MS1H2 mounting dimensions ($N_{\text{rated}} = 3,000 \text{ RPM}$, $N_{\text{max}} = 5,000/6,000 \text{ RPM}$)

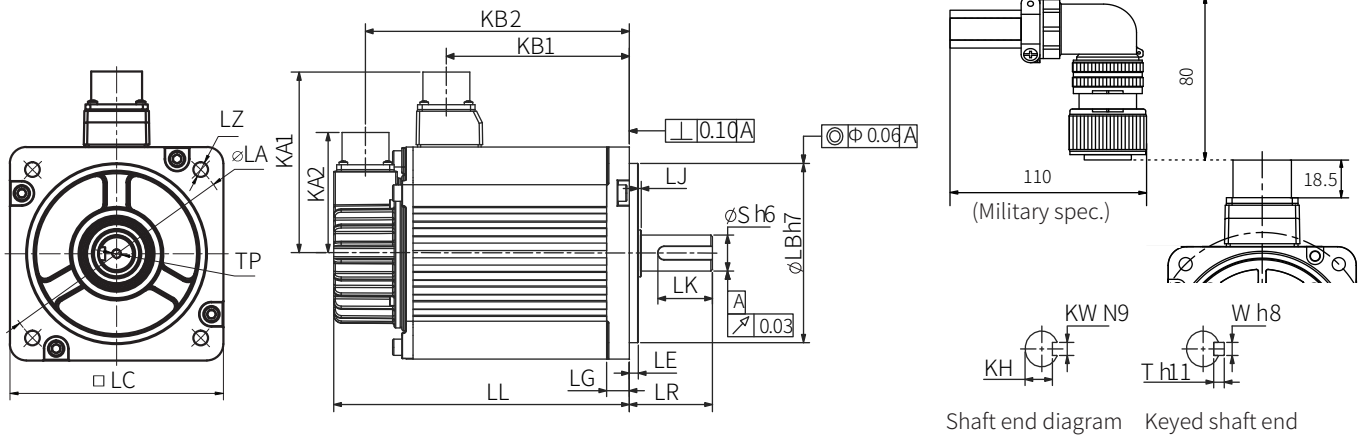

Model	LC (mm)	LL (mm)	LR (mm)	LA (mm)	LZ (mm)	KA1 (mm)	KB1 (mm)	KA2 (mm)	KB2 (mm)	LG (mm)	LE (mm)	LJ (mm)	LB (mm)
MS1H2-10C30CB(D)-XXXXZ-INT	100	164 (213.5)*	45±1	115	4-Φ7	88	94.5 (101)*	74	143.5 (192.5)*	10	5±0.3	2.5±0.75	95
MS1H2-15C30CB(D)-XXXXZ-INT	100	189 (239)*	45±1	115	4-Φ7	88	119.5 (128)*	74	168.5 (219.5)*	10	5±0.3	2.5±0.75	95
MS1H2-20C30CD-XXXXZ(-S4)-INT	100	214 (265)*	45±1	115	4-Φ7	88	144.5 (153)*	74	193.5 (244)*	10	5±0.3	2.5±0.75	95
MS1H2-25C30CD-XXXXZ(-S4)-INT	100	240.5 (290)*	45±1	115	4-Φ7	88	169.5 (178)*	74	218.5 (269)*	10	5±0.3	2.5±0.75	95
MS1H2-30C30CD-XXXXZ(-S4)-INT	130	209.5 (265.5)*	63±1	145	4-Φ9	103	136 (139)*	74	188.5 (244.5)*	14	6±0.3	0.5±0.75	110
MS1H2-40C30CD-XXXXZ(-S4)-INT	130	252 (308)*	63±1	145	4-Φ9	103	178.5 (181.5)*	74	231 (287)*	14	6±0.3	0.5±0.75	110
MS1H2-50C30CD-XXXXZ(-S4)-INT	130	294.5 (350.5)*	63±1	145	4-Φ9	103	221 (224)*	74	273.5 (329.5)*	14	6±0.3	0.5±0.75	110

Model	S (mm)	TP (mm)	LK (mm)	KH (mm)	KW (mm)	W (mm)	T (mm)	Weight (kg)	Connector	Power side (incl. power brake side)	Encoder side
MS1H2-10C30CB(D)-XXXXZ-INT	24	M8×16	36	20 ⁰ _{-0.2}	8	8	7	5.11 (6.41)*	Aviation plug	MI-DTL-5015 3102E20-18P	MI-DTL-5015 3102E20-29P
MS1H2-15C30CB(D)-XXXXZ-INT	24	M8×16	36	20 ⁰ _{-0.2}	8	8	7	6.22 (7.52)*			
MS1H2-20C30CD-XXXXZ(-S4)-INT	24	M8×16	36	20 ⁰ _{-0.2}	8	8	7	7.39 (8.7)*			
MS1H2-25C30CD-XXXXZ(-S4)-INT	24	M8×16	36	20 ⁰ _{-0.2}	8	8	7	8.55 (9.8)*			
MS1H2-30C30CD-XXXXZ(-S4)-INT	28	M8×20	54	24 ⁰ _{-0.2}	8	8	7	10.73 (13.2)*	Aviation plug	MI-DTL-5015 3102E20-18P	MI-DTL-5015 3102E20-29P
MS1H2-40C30CD-XXXXZ(-S4)-INT	28	M8×20	54	24 ⁰ _{-0.2}	8	8	7	15.43 (17.9)*			
MS1H2-50C30CD-XXXXZ(-S4)-INT	28	M8×20	54	24 ⁰ _{-0.2}	8	8	7	16.2 (18.7)*			

*Refers to braked version of the motor

Servo motor dimensions

MS1H3 mounting dimensions ($N_{rated} = 1,500 \text{ RPM}$, $N_{max} = 3,000 \text{ RPM}$)

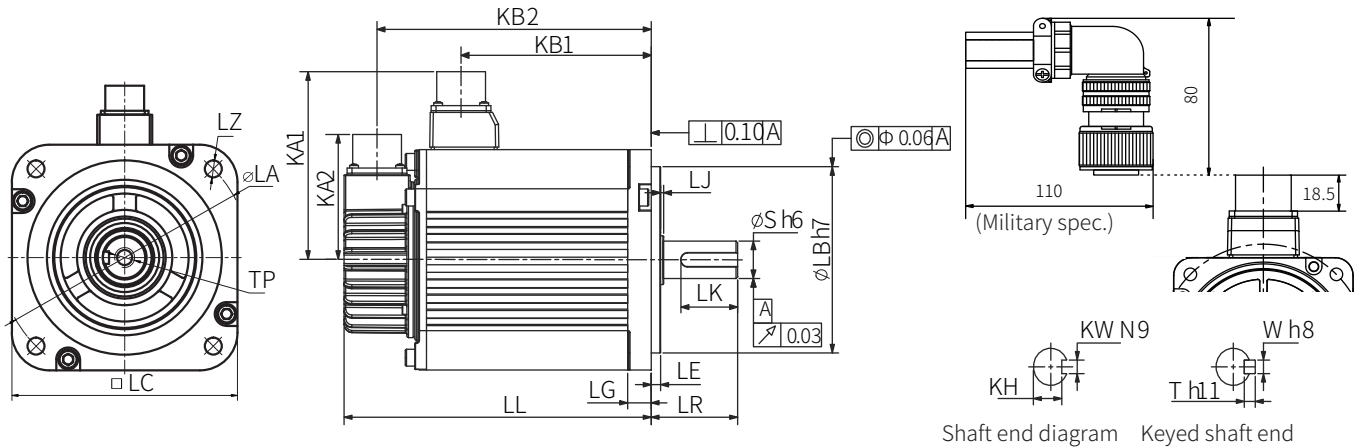

Model	LC (mm)	LL (mm)	LR (mm)	LA (mm)	LZ (mm)	KA1 (mm)	KB1 (mm)	KA2 (mm)	KB2 (mm)	LG (mm)	LE (mm)	LJ (mm)	LB (mm)
MS1H3-85B15CB(D)-XXXXZ-INT	130	146 (182)*	55±1	145	4-Φ9	103	72.5	74	125 (161)*	14	4	0.5±0.75	110
MS1H3-13C15CB(D)-XXXXZ-INT	130	163 (199)*	55±1	145	4-Φ9	103	89.5	74	142 (178)*	14	4	0.5±0.75	110
MS1H3-18C15CD-XXXXZ-INT	130	181 (217)*	55±1	145	4-Φ9	103	107.5	74	160 (196)*	14	4	0.5±0.75	110
MS1H3-29C15CD-XXXXZ-INT	180	197 (273)*	79±1	200	4-Φ13.5	138	136 (134)*	74	177 (253)*	18	3.2±0.3	0.3±0.75	114.3
MS1H3-44C15CD-XXXXZ-INT	180	230 (307)*	79±1	200	4-Φ13.5	138	169 (167)*	74	210 (286)*	18	3.2±0.3	0.3±0.75	114.3
MS1H3-55C15CD-XXXXZ-INT	180	274 (350)*	113±1	200	4-Φ13.5	138	213 (211)*	74	254 (330)*	18	3.2±0.3	0.3±0.75	114.3
MS1H3-75C15CD-XXXXZ-INT	180	330 (407)*	113±1	200	4-Φ13.5	138	269 (267)*	74	310 (386)*	18	3.2±0.3	0.3±0.75	114.3

Model	S (mm)	TP (mm)	LK (mm)	KH (mm)	KW (mm)	W (mm)	T (mm)	Weight (kg)	Connector	Power side (incl. power brake side)	Encoder side
MS1H3-85B15CB(D)-XXXXZ-INT	22	M6×20	36	18 ⁰ _{-0.2}	8	8	7	7 (8)*	Aviation plug	MI-DTL-5015 3102E20-18P	MI-DTL-5015 3102E20-29P
MS1H3-13C15CB(D)-XXXXZ-INT	22	M6×20	36	18 ⁰ _{-0.2}	8	8	7	8 (9.5)*			
MS1H3-18C15CD-XXXXZ-INT	22	M6×20	36	18 ⁰ _{-0.2}	8	8	7	9.5 (11)*			
MS1H3-29C15CD-XXXXZ-INT	35	M12×25	65	30 ⁰ _{-0.2}	10	10	8	15 (25)*	Aviation plug	MI-DTL-5015 3102E20-22P	MI-DTL-5015 3102E20-29P
MS1H3-44C15CD-XXXXZ-INT	35	M12×25	65	30 ⁰ _{-0.2}	10	10	8	19.5 (30)*			
MS1H3-55C15CD-XXXXZ-INT	42	M16×32	96	37 ⁰ _{-0.2}	12	12	8	28 (38)*			
MS1H3-75C15CD-XXXXZ-INT	42	M16×32	96	37 ⁰ _{-0.2}	12	12	8	32 (42)*			

*Refers to braked version of the motor

Servo motor torque VS speed graph

A (continuous operation area) & B (short term operation area)

MS1H1: low inertia
small capacity

MS1H4: high inertia
small capacity

MS1H2: low
medium capacity

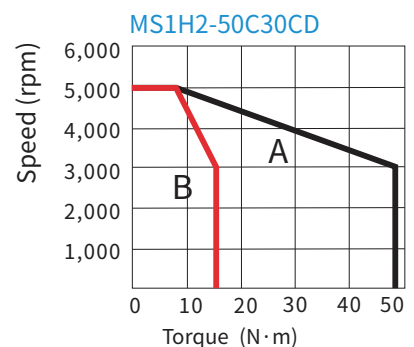
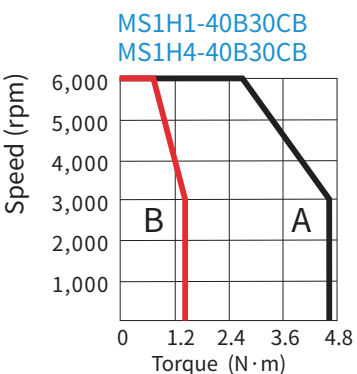
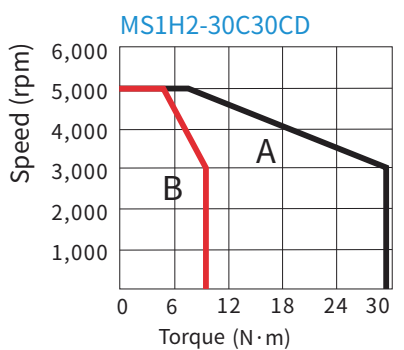
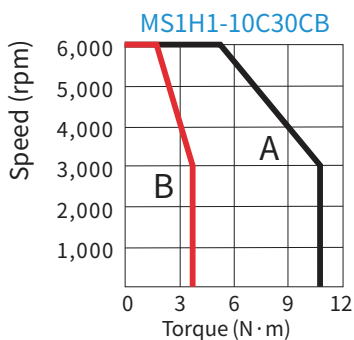
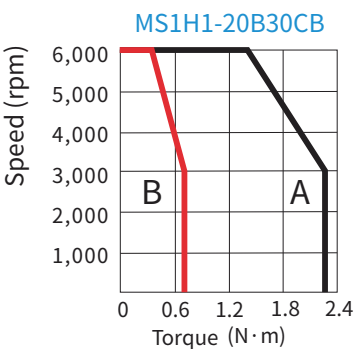
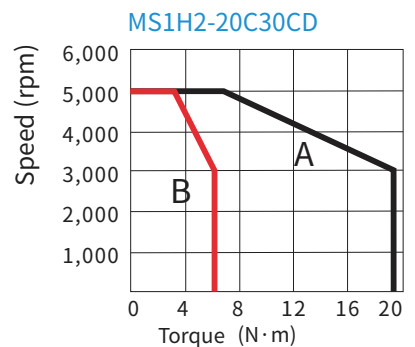
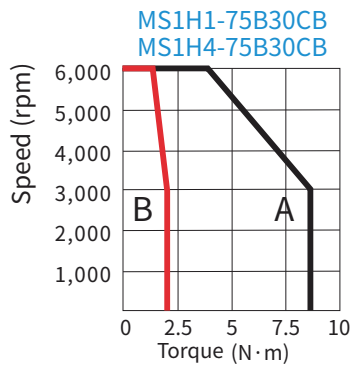
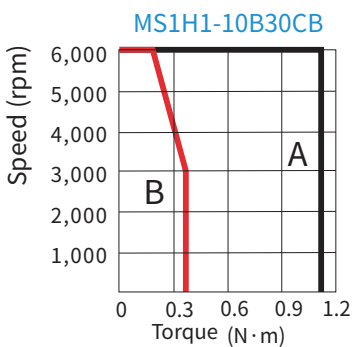
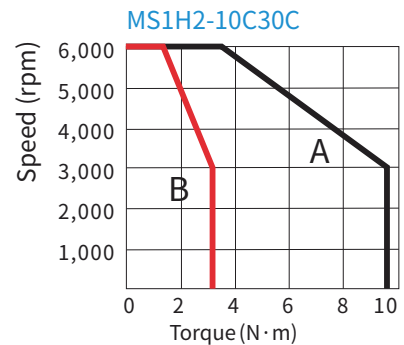
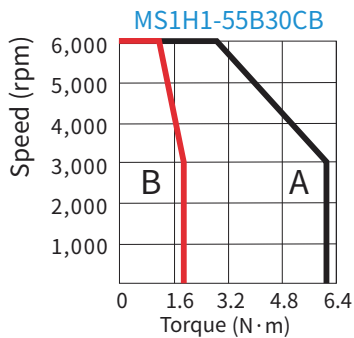
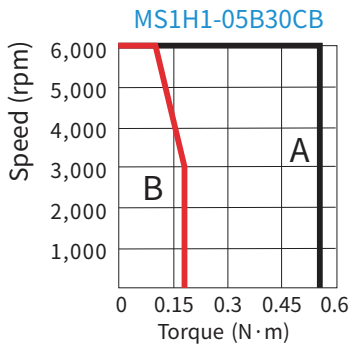

Low inertia
capacity

MS1H3: high inertia
medium capacity

MS1H2-15C30C

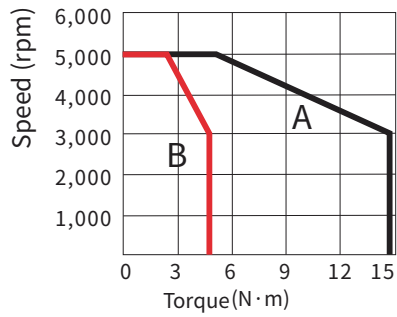

MS1H3-85B15C

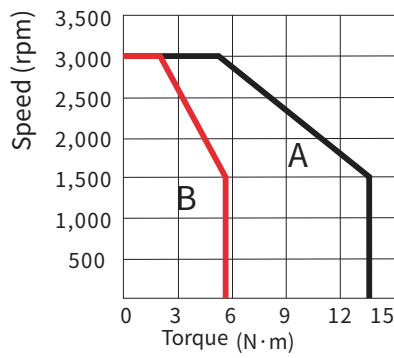

MS1H3-13C15C

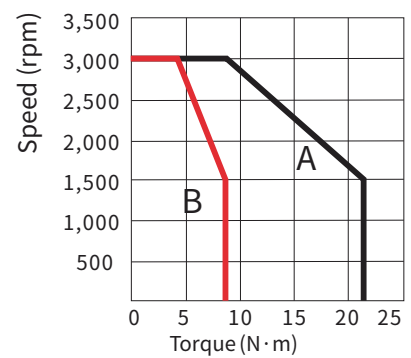

MS1H2-25C30CD

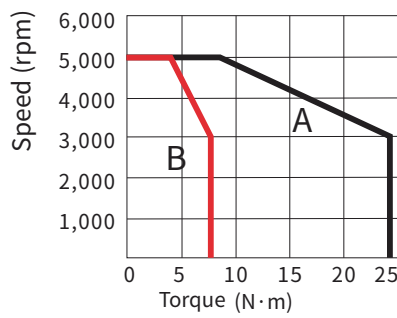

MS1H3-18C15CD

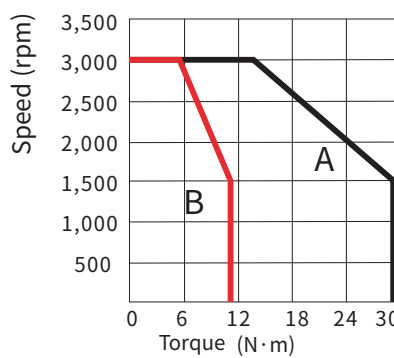

MS1H3-29C15CD

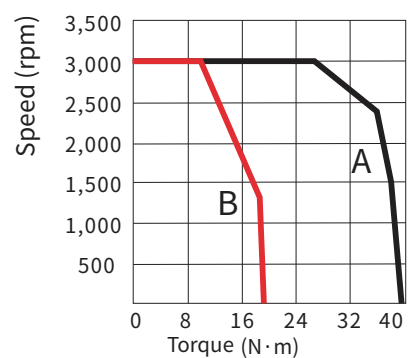

MS1H2-40C30CD

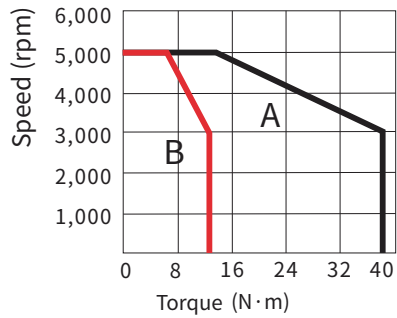

MS1H3-44C15CD

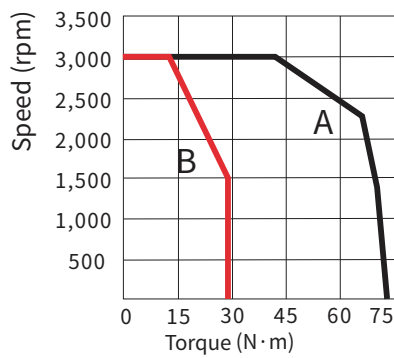

MS1H3-55C15CD

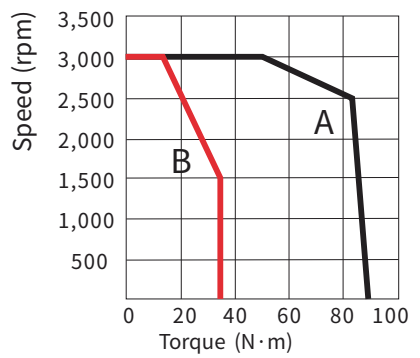

MS1H3-75C15CD

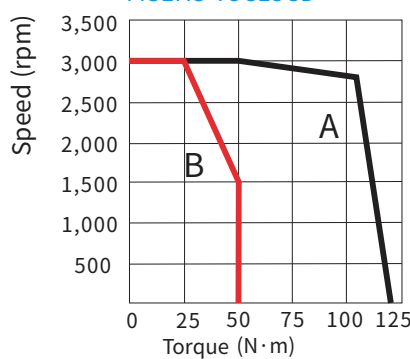

Servo motor overload characteristics graph

Overload characteristics

Load ratio (%)	Running time (s)
120	230
130	80
150	40
150	30
160	20
170	17
180	15
190	12
200	10
210	8.5
220	7
230	6
240	5.5
250	5
300	3
350	2

Note: MS1H1 / MS1H4 motor = 3.5 x rated torque
 MS1H2 motor = 3 x rated torque
 MS1H3 (excluding 2.9 kW) = 2.5 x rated torque
 MS1H3 (2.9kW) = Max. 2 x rated torque

Radial/axial allowable load

Motor model	Frame size (mm)	LF (mm)	Radial allowable load (N)	Axial allowable load (N)
MS1H1-05B30CB	40	20	78	54
MS1H1-10B30CB	40	20	78	54
MS1H1-20B30CB	60	25	245	74
MS1H1-40B30CB	60	25	245	74
MS1H1-55B30CB	80	35	392	147
MS1H1-75B30CB	80	35	392	147
MS1H1-10C30CB	80	35	382	147
MS1H2-10C30CB	100	45	686	196
MS1H2-10C30CD	100	45	686	196
MS1H2-15C30CB	100	45	686	196
MS1H2-15C30CD	100	45	686	196
MS1H2-20C30CD	100	45	686	196
MS1H2-25C30CD	100	45	686	196
MS1H2-30C30CD	130	63	980	392
MS1H2-40C30CD	130	63	1176	392
MS1H2-50C30CD	130	63	1176	392
MS1H3-85B15CB	130	45	686	196
MS1H3-13C15CB	130	45	686	196
MS1H3-85B15CD	130	45	686	196
MS1H3-13C15CD	130	45	686	196
MS1H3-18C15CD	130	45	686	196
MS1H3-29C15CD	180	79	1470	490
MS1H3-44C15CD	180	79	1470	490
MS1H3-55C15CD	180	113	1764	588
MS1H3-75C15CD	180	113	1764	588
MS1H4-40B30CB	60	25	245	74
MS1H4-75B30CB	80	35	392	147

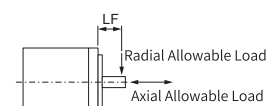

Figure 1-6 Diagram of radial and axial loads

Quick selection chart

Servo motor type	Servo drive type	Type code cables			Type code connector kits (2)
		Encoder cable	Power cable without brake	Power cable with brake	
MS1H1/MS1H4	SV660	Back outlet: S6x-L-P125-XX.X-yz(-INT) Front outlet: S6x-L-P124-XX.X-yz(-INT)	Back outlet: S6x-L-M108-XX.X-yz(-INT) Front outlet: S6x-L-M107-XX.X-yz(-INT)	Back outlet: S6x-L-B108-XX.X-yz(-INT) Front outlet: S6x-L-B107-XX.X-yz(-INT)	S6-C22
MS1H2 < 4 kW		S6x-L-P121-XX.X-yz(-INT)	S6x-L-M111-XX.X-yz(-INT) S6x-L-M011-XX.X-yz(-INT) (1)	S6x-L-B111-XX.X-yz(-INT) S6x-L-B011-XX.X-yz(-INT) (1)	S6-C29 (3)
MS1H2 ≥ 4 kW			S6x-L-M011-XX.X-yz(-INT)	S6x-L-B011-XX.X-yz(-INT)	S6-C29 (3)
MS1H3 ≤ 1.8 kW			S6x-L-M111-XX.X-yz(-INT)	S6x-L-B111-XX.X-yz(-INT)	S6-C29
MS1H3 2.9 kW			S6x-L-M112-XX.X-yz(-INT)	S6x-L-M112-XX.X-yz(-INT)	S6-C39
MS1H3 > 2.9 kW			S6x-L-M022-XX.X-yz(-INT)	S6x-L-B022-XX.X-yz(-INT)	S6-C39 (3)
MS1H1/MS1H4	IS810N	Back outlet: S6x-L-P025-XX.X-yz(-INT) Front outlet: S6x-L-P024-XX.X-yz(-INT)	Back outlet: S6x-L-M108-XX.X-yz(-INT) Front outlet: S6x-L-M107-XX.X-yz(-INT)	Back outlet: S6x-L-B108-XX.X-yz(-INT) Front outlet: S6x-L-B107-XX.X-yz(-INT)	N/A
MS1H2		S6x-L-P021-XX.X-yz(-INT)	S6x-L-M111-XX.X-yz(-INT)	S6x-L-B111-XX.X-yz(-INT)	S6-C29
MS1H3 ≤ 1.8 kW			S6x-L-M111-XX.X-yz(-INT)	S6x-L-B111-XX.X-yz(-INT)	S6-C29
MS1H3 2.9 kW			S6x-L-M112-XX.X-yz(-INT)	S6x-L-B112-XX.X-yz(-INT)	S6-C39
MS1H3 > 2.9 kW			S6x-L-M122-XX.X-yz(-INT)	S6x-L-B122-XX.X-yz(-INT)	S6-C39
MS1H1/MS1H4	SV670 SV680	Back outlet: S6x-L-P125-XX.X-yz(-INT) Front outlet: S6x-L-P124-XX.X-yz(-INT)	Back outlet: S6x-L-M108-XX.X-yz(-INT) Front outlet: S6x-L-M107-XX.X-yz(-INT)	Back outlet: S6x-L-B108-XX.X-yz(-INT) Front outlet: S6x-L-B107-XX.X-yz(-INT)	S6-C22
MS1H2 < 4 kW		S6x-L-P121-XX.X-yz(-INT)	S6x-L-M111-XX.X-yz(-INT)	S6x-L-B111-XX.X-yz(-INT)	S6-C29
MS1H2 ≥ 4 kW			S6x-L-M111-XX.X-yz(-INT)	S6x-L-B111-XX.X-yz(-INT)	S6-C29
MS1H3 ≤ 1.8 kW			S6x-L-M111-XX.X-yz(-INT)	S6x-L-B111-XX.X-yz(-INT)	S6-C29
MS1H3 2.9 kW			S6x-L-M112-XX.X-yz(-INT)	S6x-L-M112-XX.X-yz(-INT)	S6-C39
MS1H3 > 2.9 kW			S6x-L-M022-XX.X-yz(-INT)	S6x-L-B022-XX.X-yz(-INT)	S6-C39

Notes:

XX.X: Cable length in meters

Back outlet is default selection of the cables for MS1H1/MS1H4 motors

MS1H1/H4 motors are with low profile connectors (plastic)
MS1H2/H3 are with with Mil specification connectors (metal)

S6x: Indicates cable origin (internal use)
E: Europe
I: PVC international

yz:
T: PVC shielded, flexible, non oil resistant
TO-INT: PVC shielded, flexible, oil resistant, CE certified, UL recognized
US-INT: PUR shielded, flexible, oil resistant, CE certified, UL recognized"

yz:
TS: PVC shielded, flexible, non oil resistant
TS-INT: PVC shielded, flexible, oil resistant, CE certified, UL recognized
US-INT: PUR shielded, flexible, oil resistant, CE certified, UL recognized

(1) When combined with SIZE E servo drives use this type

(2) For customers making their own cable assemblies, connector kits shown here can be ordered separately
(3) Bootlace ferrules supplied

For more detailed cable information, contact your local Inovance representative

Driven by Technology

AC Drives



AC MultiDrives



MV Drives



Single-Axis Servos



Multi-Axis Servos



Robotics & Motion Controllers



PLCs & HMIs



CNC Machine Tool Solutions



Electric Vehicle Inverters

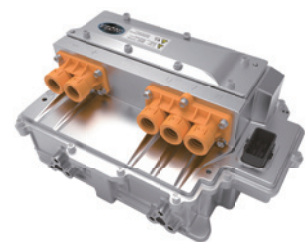

For more information, please contact our local offices.

International Offices

Germany-Stuttgart

Tel: +49 (0) 7144 8990
sales.de@inovance.eu

Italy-Milano

Tel: +39 (0) 2268 22318
sales.it@inovance.eu

France-Bordeaux

Tel: +33 (0) 5594 01050
sales.fr@inovance.eu

Turkey-Istanbul

Tel: +90 (216) 706 17 89
info@inovance.eu

South Korea-Seoul

Tel: +82 (0) 10 7428 5732
info@inovance.eu

India

Head Office Chennai
Tel: +91 (0) 44 4380 0201

Ahmedabad

Tel: +91 794003 4272

Mumbai

Tel: +91 22 4971 5883

New Delhi

Tel: +91 11 4165 4524

Sales Network in Kolkata, Bengaluru, Pune,
Coimbatore, Hyderabad, Vadodara, Jaipur
Email: info@inovance.ind.in

Hong Kong SAR

International Export Office

Tel: +852 2751 6080

info@inovance.eu

For other country distributors,
contact the Hong Kong office.

Inovance Technology Companies

Shenzhen Inovance Technology Co. Ltd.
Suzhou Inovance Technology Co. Ltd.

INOVANCE
www.inovance.eu